

**medlink**  
IMAGING

Optima URS  
*plus* LP

Universal Radiographic  
System ▶▶▶

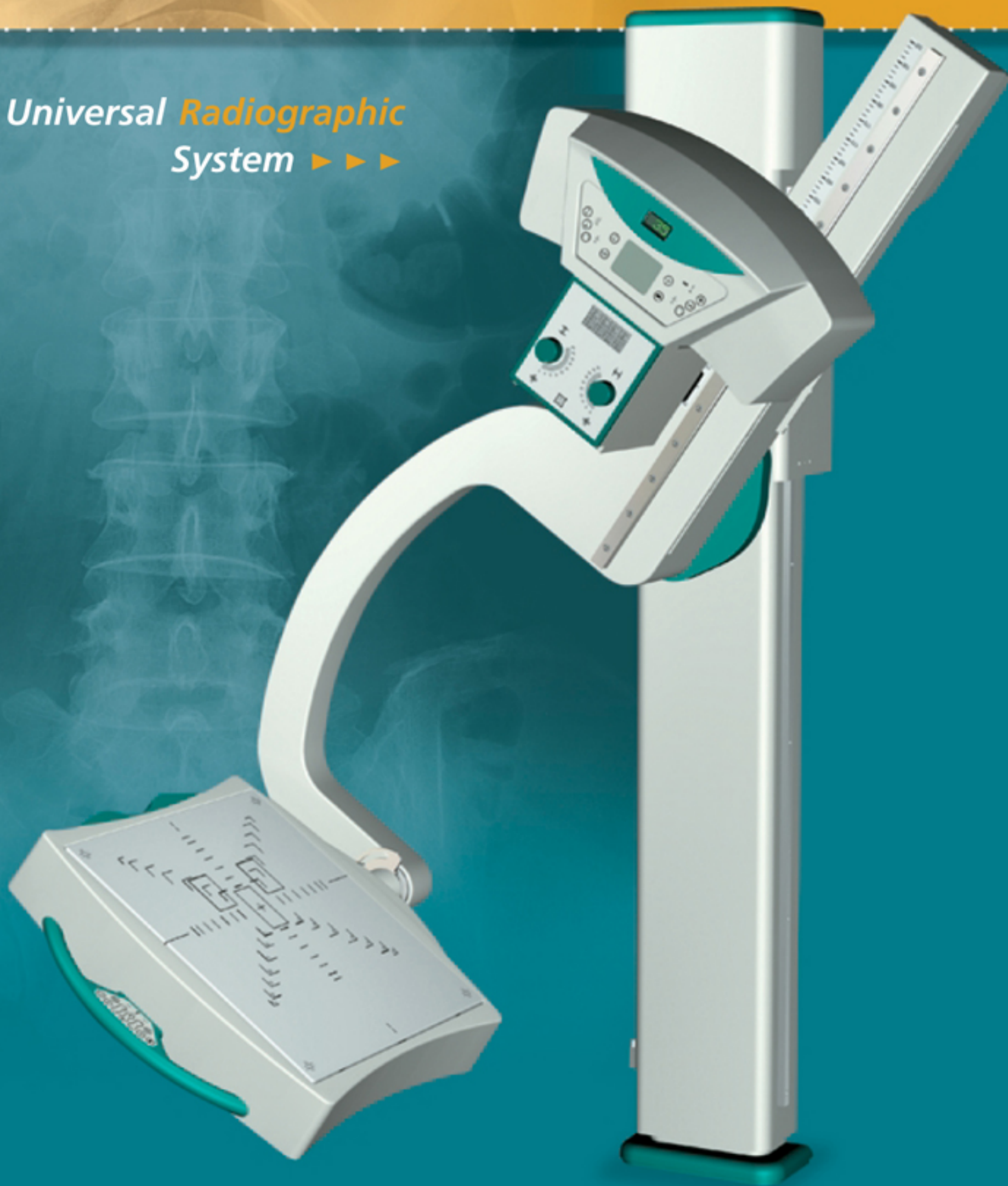

# Optima URS *plus* LP

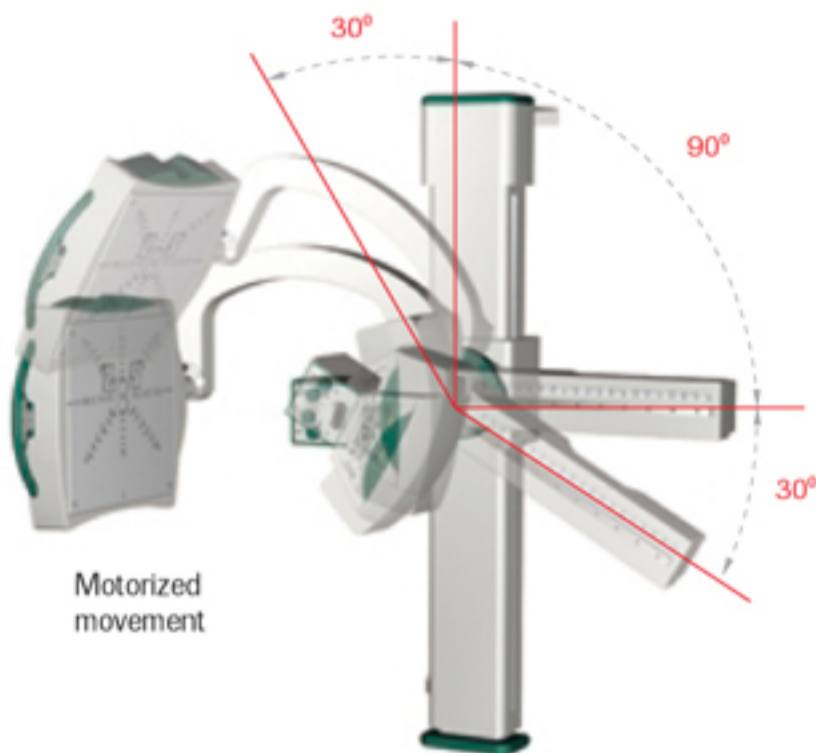

Motorized movement

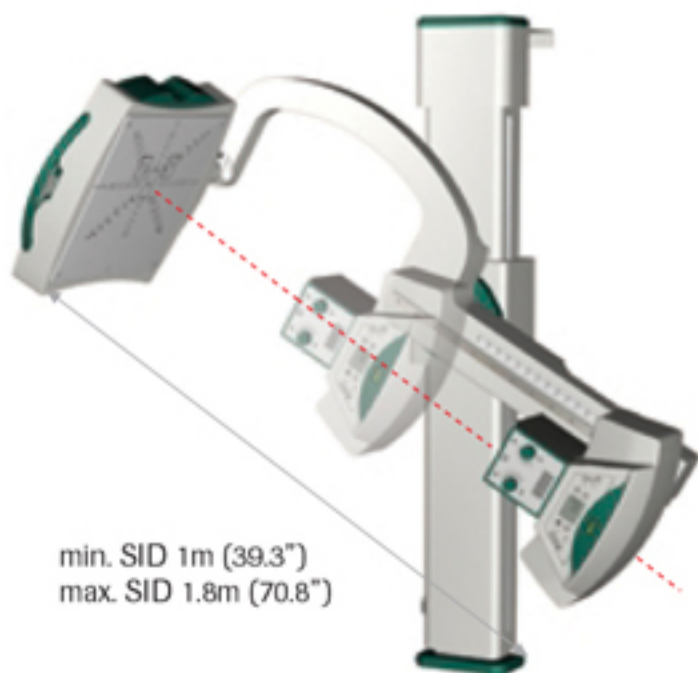

min. SID 1m (39.3")  
max. SID 1.8m (70.8")

Medlink Optima URS Plus LP system has been designed as a world-class direct digital imaging systems for use in hospital emergency departments, traumatology and all general radiology applications.

The C-arm design maintains constant alignment between the x-ray tube and image receptor, regardless of C-arm tilt positions or image receptor angle. Its extraordinary flexibility makes the system ideal for all patients in standing, sitting or laying position, including those who are disabled or physically restricted.

All system movements are motorized.

The image receptor rotates within a range of +/- 45° to allow for various studies

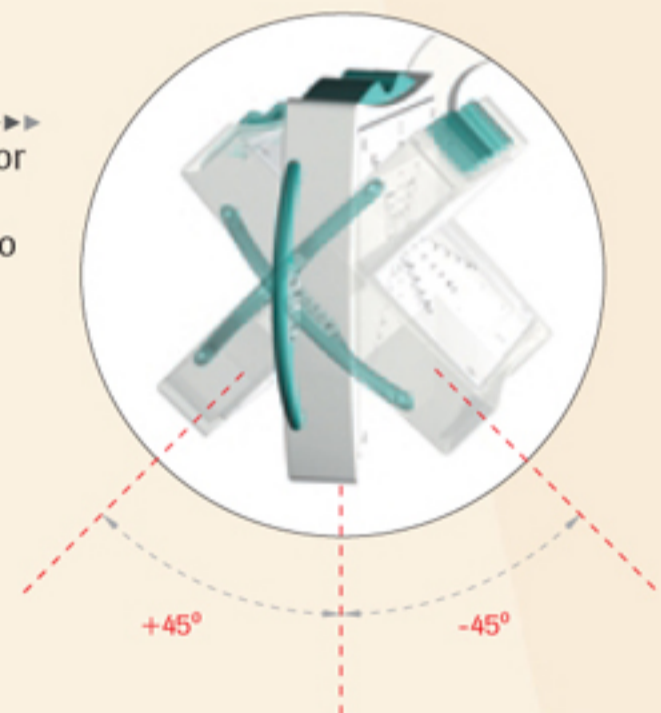

## 100-180 cm. (40-72") VARIABLE SOURCE-TO-IMAGE DISTANCE

Medlink Optima URS Plus LP provides a variable source to image distance (SID) of 100 to 180 cm (40"-72") to accommodate a range of radiographic studies.

The x-ray tube assembly can be easily moved from 100 to 180 cm (40"-72") at any C-arm angle position, by using the operator hand control.

## POSITIONING FLEXIBILITY AND EASE OF USE FOR ALL PROCEDURES

The system's operator-friendly controls dual speed motorized movements, and the intelligent anti-collision system makes the patient positioning quick, easy and safe.

User-friendly console and constant alignment of x-ray table and digital image receptor guarantee efficient and confident diagnosis.



The Universal X plus LP C-arm design accommodates cross-table procedures for easy patient positioning.

With the patient table the patient can be moved into any required position without the need for repositioning.

## DIGITAL TECHNOLOGY

### Advantages of digital radiography

- ▶ Faster exam times, resulting in more patient throughput and increased productivity.
- ▶ Greater visualization of soft tissue and bone from the same study exposure (wide dynamic range).
- ▶ Significant reduction in repeat patient exposures.

Medlink Optima URS Plus LP can be equipped with any digital x-ray detector up to 43 x 43 cm. (17" x 17") size.

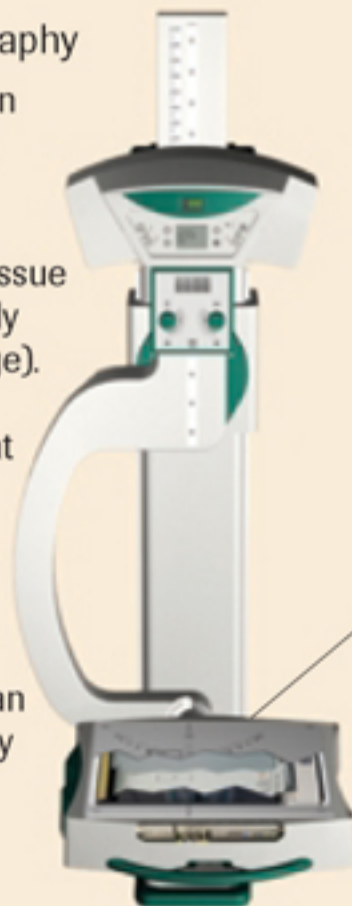

Digital Detector Assembly  
◀◀◀

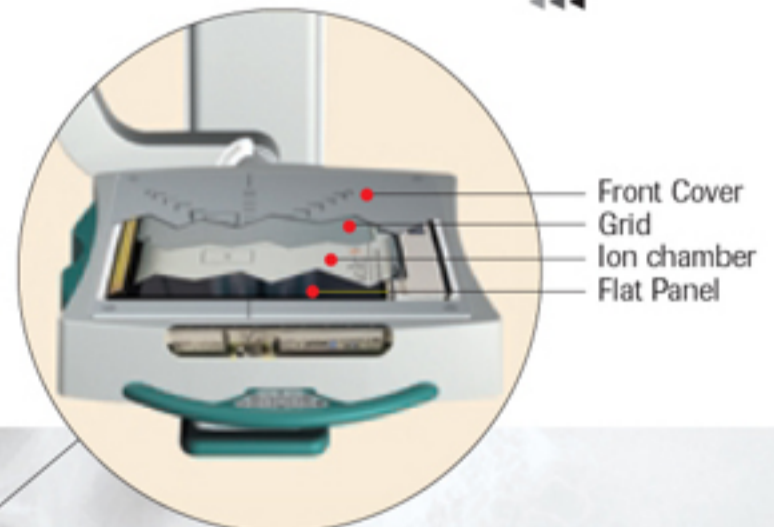

Front Cover  
Grid  
Ion chamber  
Flat Panel

# SPECIFICATIONS

## BASIC UNIT

Source-to-image distance (SID)	100-180 cm / 39.4"-70.9" continuously adjustable (dual-speed motorized movement)
Power supply	115, 208, 230, 240 VAC; single phase, 1.5 kVA
Dimensions (H x W x D)	2.650 mm x 2.110 mm x 1.680 mm / 104.3" x 83" x 66"

## SWIVEL ARM

	Dual-speed motorized movement (for SID and vertical travel)
Vertical Travel	1.150 mm / 45.3"
Range of rotation	150° (90° +/- 30°)

## BUCKY UNIT

Type - Grid	- digital captor (max. image size: 43 cm x 43 cm / 17" x 17") - range of tilt: +/- 45°
	1) Reciprocating bucky (oscillating grid) (103 lines / Ratio 12:1 / f = 150 cm / 59")
	2) Grid cabinet + non oscillating interchangeable grid
	a) 1st. grid - 180 lines / Ratio 12:1 / f = 100 cm / 39.4"
	b) 2nd grid - 180 lines / Ratio 12:1 / f = 180 cm / 70.9"

## MOBILE PATIENT TABLE

Table-top composition	Laminated structure
Patient capacity	160 kg / 352.7 lb
Dimensions (L x W x H)	2.000 mm x 650 mm x 700 mm / 78.7" x 25.6" x 27.6"

## OPTIONS

Mobile table	Carbon fiber table top - Patient capacity: 200 kg / 441 lb
Collimator	Automatic collimator
Unit fixation system	Floor to ceiling mounting support

## MAIN COLUMN

Floor to wall mounted support  
Dual-speed motorized swivel arm  
vertical movement for effortless  
and accurate setting

## X- RAY GENERATOR

Radiologia Compact X-ray generator  
(line powered / battery powered /  
capacitor assisted)

## COLLIMATOR

- Manual type collimator
- **Linear laser beam** for patient positioning in combination with light field indicator
- Rails for accesories
- Measuring tape

## WEIGHTS

- Medlink Optima URS Plus LP net wight: 324 kg / 714.3 lb (mobile table and digital image detector are not included)
- Mobile table net weight: 46 kg / 101.4 lb

## DIMENSIONS

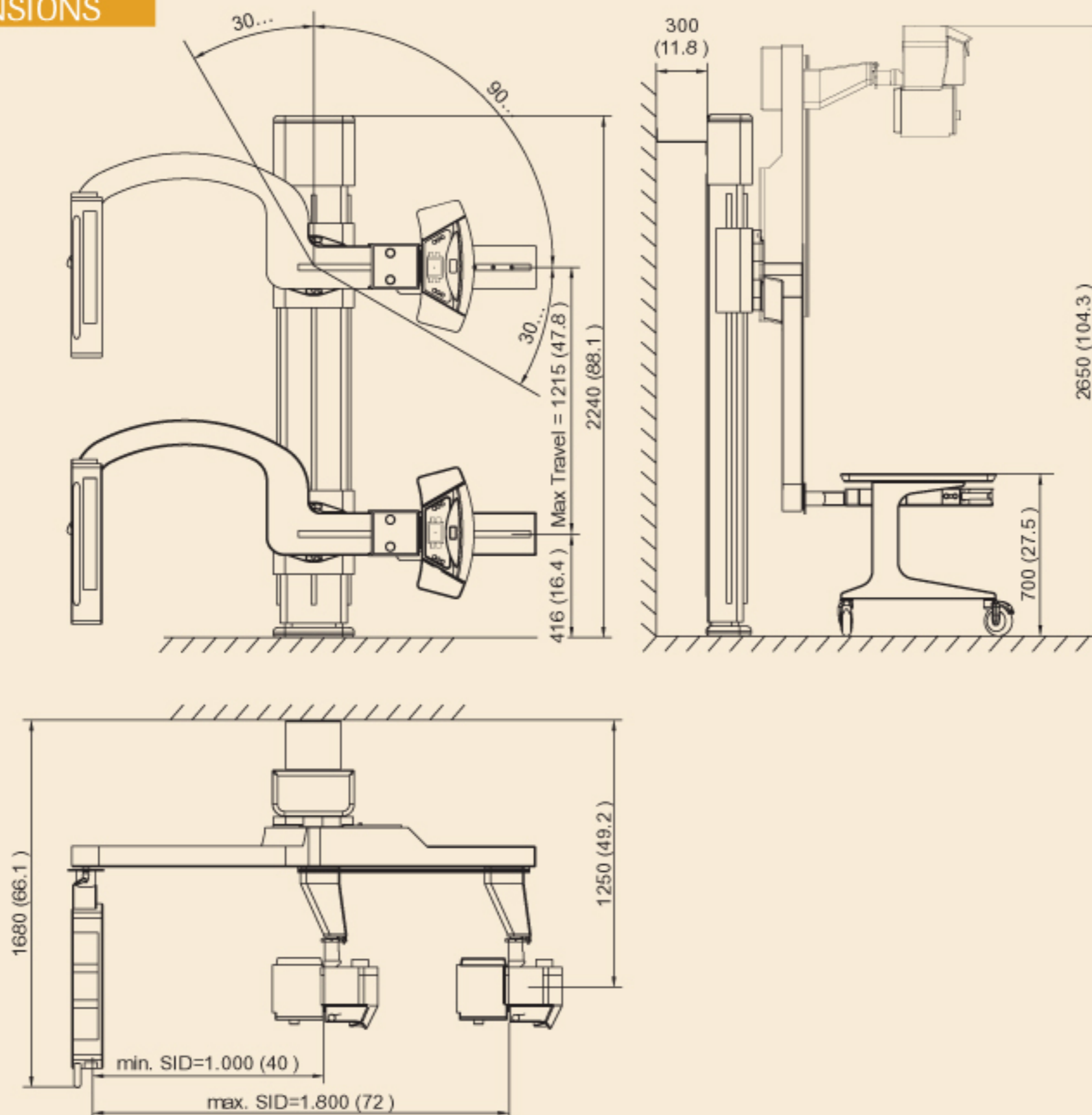

Specifications subject to change without prior notice



Carbon Fiber Table Top  
(Optional Mobile Table)



Stratified Laminated Table Top  
(Standard Mobile Table)



New York Corporate Office  
& Distribution Center  
200 Clearbrook Road  
Elmsford, NY 10523

Toll Free: 800-456-7800  
914-347-0102  
Fax: 888-437-9729

California Distribution Center  
517 Maple Avenue  
Carpinteria, CA 93013